

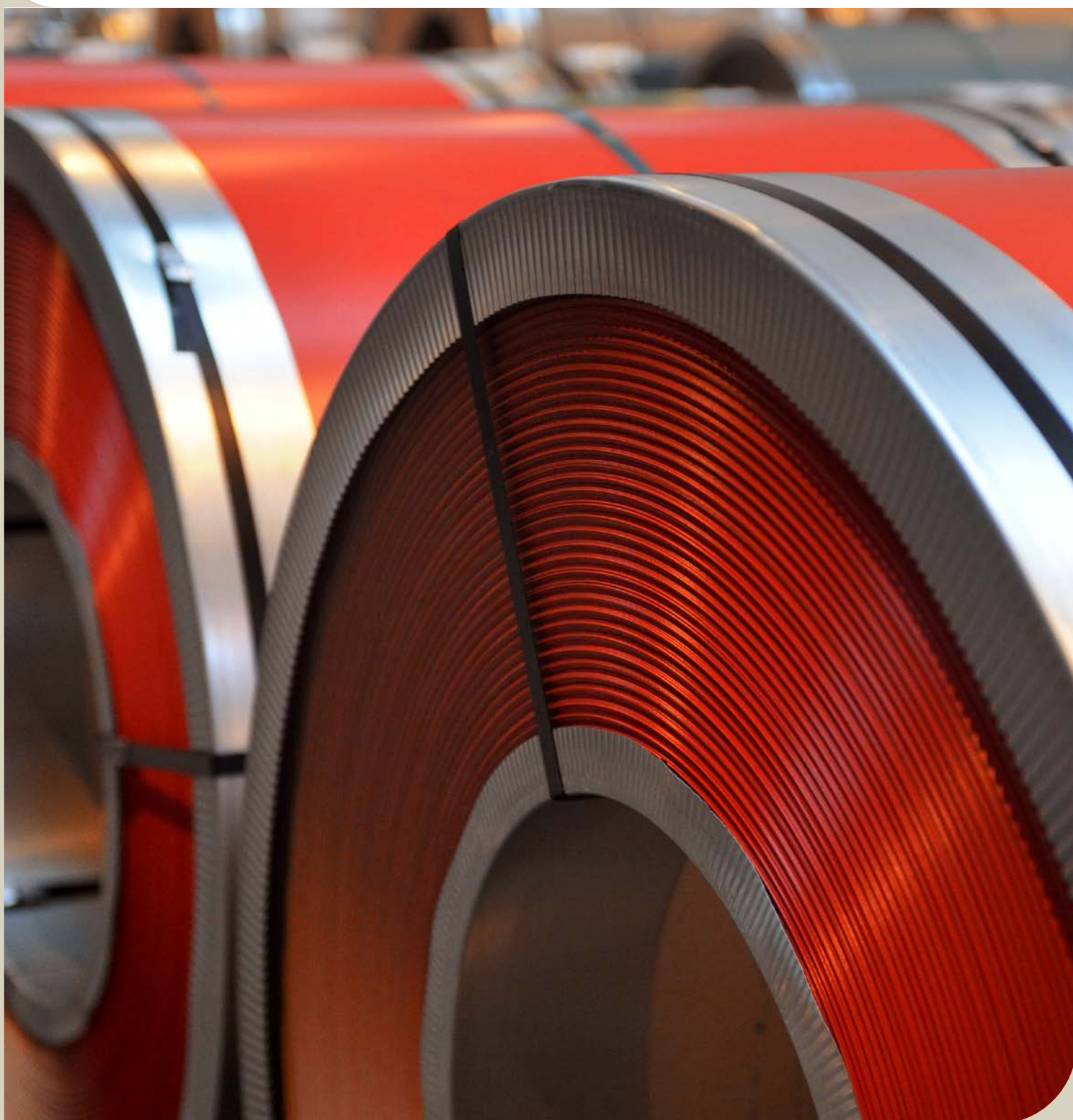

ArcelorMittal

Organic coated steel

User manual



User manual

Organic coated steel

1	Introduction	5
2	Organic coated products	9
3	General recommendations for use	15
4	Forming of organic coated steel	21
5	Joining of organic coated steel	27
6	Protection and manufacturing aids	33
7	Design	35



1 Introduction

Today, organic coated steel offers exceptional economic and technological advantages, which explains its extraordinary success story in industry.

Organic coated steel products are used in all sectors of industry. In building and construction, profiles are used for wall cladding and roofing, and also for applications such as suspended ceilings, lighting etc. In general industry, these products have a variety of applications, including metal furniture, HVAC (heating, ventilation and air conditioning) and many others. And the advantages of organic coated steel products are, of course, well known in the domestic appliance market, where they are successfully used for white goods (refrigerators, washing machines etc) and small kitchen appliances (microwave ovens etc). Brown goods (LCDs, LED TV back panels, computer casings, VCR & DVD casings etc) are another successful application.

The purpose of this document is to give you all the information you need to take maximum advantage of everything organic coated steel has to offer. It is no more than a technical support tool, however, and is not intended as a substitute for direct contact with our technical experts and account managers.

Advantages

economic

Coil coating lines provide high productivity and yield, reducing the cost of applying an organic coating. Line speeds are frequently around 100 m/min, **up to a maximum of 170 m/min.**

For users, switching from post-painting to organic coated material means that they no longer need to invest in their own paint shop, degreasing installations and other surface treatment equipment, or the ensuing waste treatment.

The use of coil coated steel simplifies manufacturing operations and provides a drastic reduction in:

- Manufacturing costs
- Energy costs
- Manufacturing lead time
- The financial cost of managing stocks (raw materials, chemicals and intermediate storage)

Furthermore, the use of organic coated steel significantly reduces company taxes and insurance premiums. All taxes related to waste treatment are eliminated. In some cases, the move towards clean manufacturing can benefit from subsidies from the State and/or the European Union.

ecological

Organic coated steel is certainly one of the products best able to respond to present and future environmental regulations. ArcelorMittal has opted for a proactive approach to the evolution of these regulations by building respect for the environment into the life cycle of its organic coated steel products. This strategy is pursued at all stages of the product's life cycle:

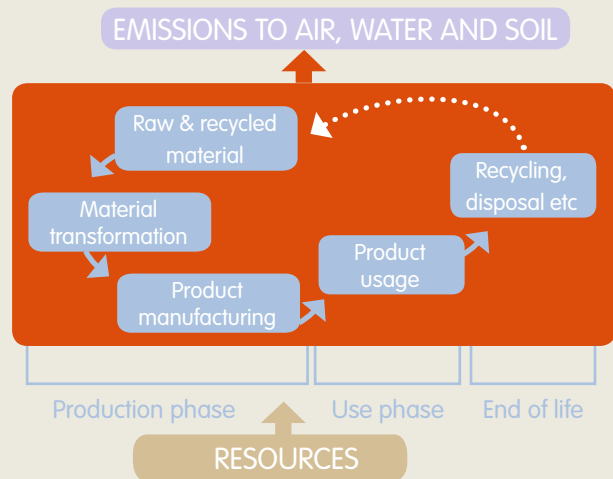

- **Design:** When designing new products or production processes, research teams take their possible environmental impact into account from the earliest stages of the project.
- **Production:** Organic coated steel is produced on industrial lines designed to meet the most stringent environmental regulations concerning surface treatment, solvent emission and the absence of harmful substances in the composition of the paint.
- **Transformation:** Using organic coated steel improves working conditions in the workshop by eliminating the use of solvents and the handling and storage of chemicals.
- **Usage:** Organic coated steel poses no danger to consumers or to the environment in the various sectors in which it is used, namely the construction business, domestic appliances and industry.
- **Recycling:** At the end of its life cycle, organic coated steel is recycled just like any other steel product.

ArcelorMittal is continuously improving its products:

ArcelorMittal Europe – Flat Products offers you a pioneering new range of organic coated steels, 100% sustainable and highly effective, called **Nature**.

The **Nature** collection complies with the European REACH regulation (Registration, Evaluation, Authorisation and Restriction of Chemical Substances) and is always supplied with coatings and surface treatments free of hexavalent chromium* and heavy metals (lead or hexavalent chromium complex).

Moreover, the **Nature** collection, released in 2012, is effective in terms of corrosion resistance, paint peeling and film integrity.

** Substances of Very High Concern included in the candidate list of REACH*

technological

The main advantage of organic coated steel is its consistent quality. Paint film thickness, colour matching and surface appearance are reproducible within narrow tolerances from batch to batch. The flexibility of the coil coating process allows us to produce a range of different surface finishes such as smooth, orange peel, grained, textured or embossed, which are all available in a wide choice of colours (solid, metallic, pearlescent etc) and the required degree of gloss: anything from matt to high gloss. Thanks to advanced printing technology, ArcelorMittal can also offer various printed patterns.



2 Organic coated products

2.1	The ArcelorMittal product range	10
2.1.1	Domestic appliances	10
2.1.2	Indoor building applications & general industry	10
2.1.3	Outdoor applications in building and construction	11
2.2	The coating line	12
2.2.1	Entry section	12
2.2.2	Process section	12
2.2.3	Exit section	13
2.2.4	Control section	13
2.3	Basic characteristics of organic coated steel	14

2.1 The ArcelorMittal product range

Today, ArcelorMittal can offer a complete range of organic coated steels, produced in a continuous process by applying liquid paint onto a substrate.

Our range of organic coated steel products meets the requirements of all sectors of industry.

2.1.1 Domestic appliances

A very wide range of high-gloss organic coated products is available for domestic appliances. The substrates we use for these applications are cold rolled and galvanised steel. Different steel grades are available, for example for bending and deep drawing applications. The organic coated steel to be selected for these applications depends on the end use, as indicated in the table below. In each case there are several possibilities. Do not hesitate to contact us for advice on choosing the most appropriate product for your particular application.

Product	Appearance	Application
Estetic® Cold	Smooth, grained, orange peel	Cold appliances
Estetic® Cold Flex	Smooth, grained, orange peel	Cold appliances with high deformation
Estetic® Hot	Smooth, orange peel	Cooking
Estetic® Wet	Smooth, orange peel	Washing
xcellook®	Rough, fine, very fine brushed	Domestic appliances, lifts, furniture, ceilings, decorative partitions
xceldesign®	Aesthetic pattern	Domestic appliances, lifts, furniture, ceilings, decorative partitions
xcelcolour®	Metallic twinkle	Lifts, furniture, ceilings, decorative partitions, electronic housings

2.1.2 Indoor building applications & general industry

ArcelorMittal's wide range of organic coated products covers all indoor building applications and end uses in general industry.

The steel substrates used for these applications are cold rolled steel, hot dip galvanised steel, electrogalvanised steel and galfan. The product range for indoor building applications and industry includes coatings with very specific properties, such as varnishes and primers suitable for use as a base coat and compatible with insulation foams or adhesives. Please contact us for further information on these products and the dimensions available.

Product	Appearance	Application
Estetic® Access	Smooth	Inner surface of sandwich panels, metal furniture; indoor use
Estetic® Standard	Smooth, orange peel	Air conditioners, presentation racks, radiators, casings
Estetic® Flex	Smooth, grained	Boiler casings, rolled parts, roller blinds, presentation racks
Estetic® Tex	Textured	Metal furniture, shelves and shelving units, body shells for domestic appliances
Estetic® Lighting	Smooth, grained	Lighting
Estetic® Mat	Matt	Metal ceilings, cappings, internal panels
Estetic® High Tech	Textured	Consumer electronics, decoders, hi-fi, computers, teletronics
Estetic® Conductive	Smooth conductive coating	Consumer electronics, decoders, hi-fi, computers, teletronics
Estetic® Wipe Board	Smooth	Wipe boards
Estetic® Chalk Board	Smooth	Chalk boards

2.1.3 Outdoor applications in building and construction

For these applications, the substrate is usually galvanised steel, galfan or ZnAlMg alloys. The choice of paint system depends on the environmental conditions to which the product will be exposed.

Product	Thickness (µm)	Appearance
Access A	15	Smooth
Granite® Standard	25	Smooth
Granite® HD	25	Smooth, matt, textured, grained
Granite® HDS	35	Smooth, pearly, grained
Granite® HDX	55	Grained
Granite® HFX Cool	55	Grained
Granite® Rain HDS	35	Double-sided grained
Granite® Rain HDX	55	Double-sided grained
Granite® Farm	35	Smooth
Granite® PVDF	25, 35, 45, 60	Smooth
Granite® Tex	35	Textured
Granite® Shutter	35	Textured
Granite® Boosted	25	Smooth
Granite® Flex	25	Smooth, grained
Granite® Deep Mat	35, 40	Wrinkled
Granite® Cloudy	35	Smooth
Granite® Wood	35	Smooth
Granite® Comfort	25	Smooth, grained, wrinkled
Granite® Forever	25	Smooth
Solano®	200	Smooth, embossed

ArcelorMittal's range of organic coated steel products currently includes over 80 options.

There is a choice of different colours, finishes (smooth, grained, structured, orange peel, pearly, metallic, embossed, striated, printed patterns etc), metallic coatings and steel grades. Each product has its own specific characteristics and applications. The appropriate choice is therefore crucial and should be made in close collaboration with ArcelorMittal's technical experts and account managers.

2.2 The coating line

A continuous coil coating line consists of three main sections: the entry section, the central or process section, and the exit section. In order to maintain a constant speed in the process section, which is essential to product quality, two accumulators (looping towers) are used as buffers when the entry or exit section of the line is stopped for joining or cutting the strip.

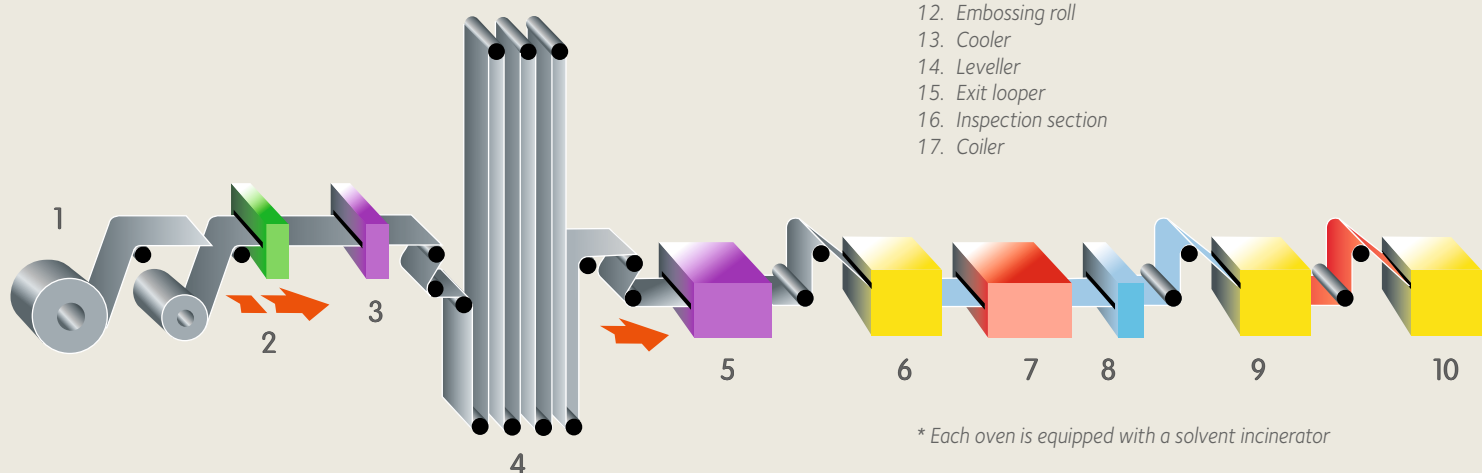

1. Pay-off reel
2. Stitching machine
3. Degreasing
4. Entry looper
5. Pretreatment
6. Coater: primer coater, top & backing coats
7. Oven*
8. Cooler
9. Coater: top
10. Coater: underside
11. Oven*
12. Embossing roll
13. Cooler
14. Leveller
15. Exit looper
16. Inspection section
17. Coiler

* Each oven is equipped with a solvent incinerator

2.2.1 Entry section

Coils are placed on a pay-off reel. To allow the process to proceed continuously, the head of the incoming coil is stitched to the tail of the coil being processed.

2.2.2 Process section

Pretreatment

The surface of the strip is prepared for coating. This pretreatment is performed in various steps. First, the strip is degreased and then a surface treatment coating is applied to improve paint adhesion and to provide a certain resistance to corrosion. The coating thickness achieved during this step is roughly 100 nm.

Coating process

The first coating heads apply liquid paint to both sides of the strip, usually primer on the top and backing coat on the underside. The strip is then passed through an oven, where the solvents are extracted and the coating cured. After leaving the oven, the strip is cooled and a top coat is applied to the upper surface in the second coating heads, followed by another curing and cooling cycle.

The curing cycles are extremely important, since they determine the aesthetic finish of the final product (colour, texture etc) and the quality of the paint system in terms of hardness, adhesion, and mechanical and chemical resistance.

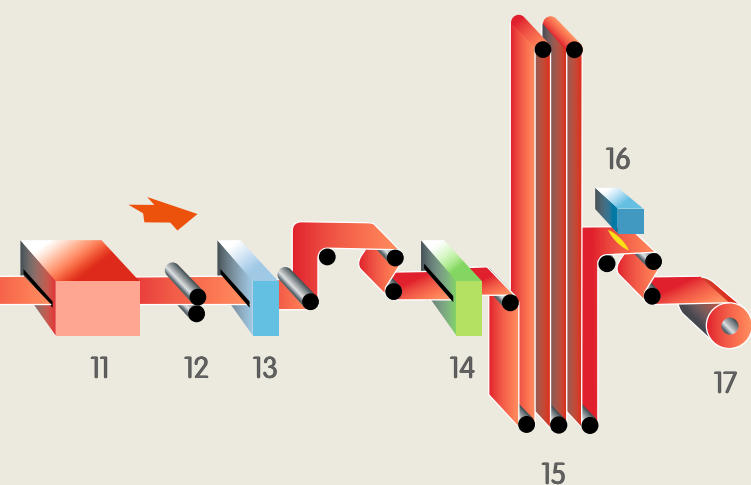

2.2.3 Exit section

The strip passes through an inspection section and finally reaches the coiler. Coil weights are adjusted to meet the customer's requirements.

A number of different on-line quality control tests are carried out. Coil coating lines comply with quality assurance standards such as ISO 9001, ISO 14001 and ISO TS 16949.

The dimensions in the table below give the overall dimensional ranges. They may vary according to the combination of product parameters specified. Please contact us for more detailed information, especially in cases where extreme thicknesses or widths are required.

Product	Thickness (mm)	Width (mm)
Organic coated products	0.17 to 3	600 to 1850

2.2.4 Control section

- **Thickness control:** Each coating thickness (primer and top coat) can be measured twice – once on line after the coater in wet conditions using an infrared device, and once after the curing section in dry conditions using a beta probe. Thanks to these two accurate measurements, in the event of any process deviations, the thicknesses can be adjusted in order to obtain a very uniform coating.
- **Temperature:** The peak metal temperature (PMT = the strip temperature) is measured continuously at the exit of each oven. The PMT should match the paint supplier's recommendations to obtain the optimum properties of the polymer. A pyrometer placed as close as possible to the strip ensures reliable measurement.
- **Colour:** After cooling, the strip colour is measured continuously using a probe travelling from one edge to the other (zigzag). Any difference compared to the standard will be automatically detected and immediately corrected. In addition to this on-line measurement, sheets are cut on a regular basis and analysed off-line in the quality lab.
- **Surface control:** The strip passes into inspection sections where trained operators thoroughly inspect the surface. Any zone with defects is reported.

To make sure the final product meets the customer's requirements, routine lab tests are also performed, including:

- Gloss assessment
- Mechanical properties (adhesion, flexibility)
- Polymer cross-linking (rub test)

2.3 Basic characteristics of organic coated steel

Organic coated steel is generally composed of a steel substrate (cold rolled or with a zinc-based metallic coating) with a surface treatment layer, a paint primer coating and a top coat. For certain applications, a temporary protective film may be added, if required.

The choice of substrate has a direct influence on the processing performance and corrosion resistance of the organic coated product. For good corrosion resistance, a relatively thick sacrificial zinc-based metallic coating is the best choice. On the other hand, if the essential requirement is an ability to withstand severe forming strains without cracking, thin and flexible crack-resistant zinc coatings are recommended.

The surface treatment carried out at the beginning of the process section prior to coating ensures good bonding between the primer and the metal substrate.

The role of the primer is mainly:

- To enhance the adhesion of the top coat
- To improve flexibility and corrosion resistance
- To determine the final texture in case of orange peel products

The top coats provide the required external surface characteristics, such as the final appearance (colour, texture, gloss, finish etc), hardness and resistance to abrasion and ultraviolet radiation. Depending on the required performance, a single (primer) or double (primer + top coat) paint layer can be applied on one or both sides of the sheet.

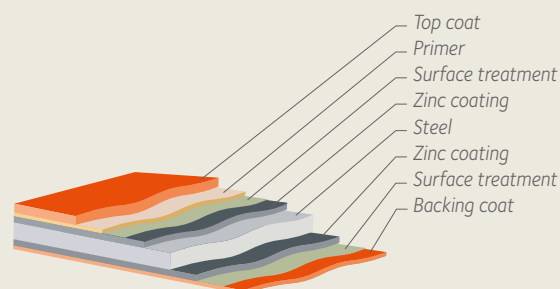

The processing performance and other characteristics required will vary greatly according to the type of substrate and the paint system used. These characteristics include paint adhesion, flexibility, hardness, resistance to surface abrasion, corrosion resistance, appearance, gloss, suitability for food contact, heat resistance, shock resistance, chemical resistance, photochemical stability (UV resistance), resistance to soiling etc.

Of course, there is no such thing as a 'universal' organic coated product that can meet all these requirements, but we have been able to develop special products for each type of application. It is often necessary to give priority to one or more properties to the detriment of others. The wide range of characteristics that can be built into organic coated products explains the diversity of the solutions proposed by ArcelorMittal. It is therefore essential to define precise prior specifications, so that we can determine the optimum solution in terms of technical and economic criteria.



3 General recommendations for use

3.1	Important notice	16
3.2	General recommendations	16
3.3	Recommendations for handling, packaging and storage	17
3.3.1	Handling	17
3.3.2	Packaging	17
3.3.3	Storage	17
3.4	Recommendations for decoiling, slitting, cutting to length, shearing, punching and mechanical cutting	18
3.4.1	Decoiling	18
3.4.2	Slitting, cutting to length, shearing, punching and mechanical cutting	18
3.4.3	Laser and water jet cutting	20
3.4.4	Compatibility with post-painting operations	20

3.1 Important notice

The sections below define an ideal processing line for organic coated sheets, and optimum working conditions. They suggest a suitable solution for every type of application. However, they must not be interpreted as mandatory, but rather as a guarantee of success.

A coil coated product and a method of processing should be chosen by selecting a suitable substrate (cold rolled steel, with or without a zinc-based metallic coating) that will meet the required specifications.

3.2 General recommendations

The first point to be borne in mind is that the surface condition of the final product is that of the coil coated sheet before processing. The second point is that the weakest link in the processing chain will determine the quality of the final product. Consequently, great care must be taken with all processing steps in order to ensure a high-quality result.

For organic coated steel, a good production process is one that retains all the initial properties of the material. Essentially, this means avoiding excessive deformation or damage to the surface, so as to preserve the corrosion resistance properties and attractive appearance of the product.

This can be achieved by observing a few basic rules:

Using dedicated processing lines and storage facilities

If workshops and equipment are used for different products, such as hot rolled strip, cold rolled strip and galvanised strip, either with or without oiling, there is a significant risk of contamination. It is worth making an economic assessment of the potential benefits of investing in dedicated equipment for organic coated material, compared with the cost of producing batches of different products on the same line, including downtime for cleaning and/or changing tools before organic coated material can be processed.

Our technical experts and account managers will be glad to help you find the best solution for you, on technical and economic grounds.

Training personnel

Working with organic coated products requires great care on the part of the operators. They must be made aware of the constraints involved, and should be given specific training. They should realise that they are dealing with a high-grade product requiring special care and different working methods.

Using an appropriate working temperature

Successful processing depends on the flexibility and hardness of the organic coating. The following graph shows how the working temperature affects these properties.

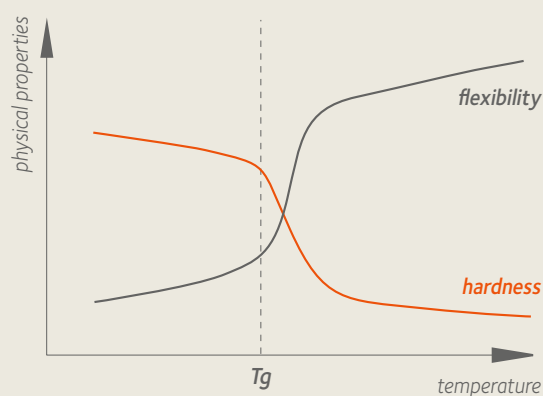

Variation in coating flexibility and hardness with temperature

For the paint to be flexible and formable, organic coated products must be processed at a temperature above the glass transformation point (T_g). This is normally the case when working at an ambient temperature of about 20°C. If it is colder in the warehouse where material is stored, the coils, sheets or blanks should be transferred to a location with a temperature of about 20°C for 24 hours prior to processing.

In extreme cases, the organic coated steel sheet can be heated locally by installing radiant infrared heaters on the processing line. This has the advantage of ensuring that the organic coating has excellent formability while retaining the same degree of hardness and chemical resistance after cooling.

However, for certain specific applications, some products need to be formed outside. In countries where temperatures are far below T_g , conventional organic coated steel can have limited flexibility in such conditions. ArcelorMittal has designed suitable products for these specific applications. For instance, Granite® HFX Cool is based on paints that have been tailor-made to withstand deformation at low temperature without cracking.

Providing inspection areas

Product inspection and monitoring should always be performed during processing, in order to detect defects such as scratches or indentations at the earliest possible stage. The ideal solution is to provide inspection areas with adequate lighting. The top side of the organic coated steel (which will be visible in the end product) must be facing upwards. Please note that the presence of a protective film may considerably hamper inspection (see p. 34).

3.3 Recommendations for handling, packaging and storage

3.3.1 Handling

Coils, sheets, blanks and components all need to be handled differently.

Equipment for handling coils should have a protective coating, e.g. sheathed non-metallic slings, and grips or C-hooks with a rubber or synthetic coating, and must be used with great care to avoid any hard impact that could mark the product.

Operators should wear gloves when handling sheets manually to protect their hands from cuts. This also keeps the surface of the sheet clean.

For automatic handling, numerous solutions are available, including robotic suction pad systems. An excellent option for both sheets and blanks is four-point seizure by suction pads. This can be further improved by installing permanent magnets at the stack edges to maintain the stack while the sheets are removed one by one.

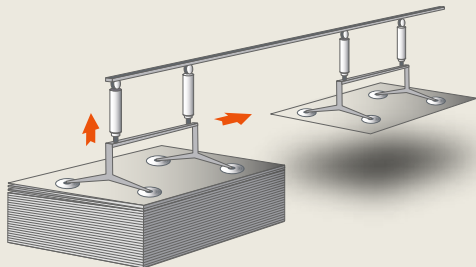

Suction pad system for handling sheets and blanks

With handling systems that involve manipulating the steel between tools (roller tables, stackers etc), the tools should make contact with the steel without slipping. Alternatively, contact should be made with a soft surface. The use of plastic transport rollers or rubber conveyor belts are possible solu-

tions. The principal requirement is to ensure a soft contact surface that does not retain dust.

Manual or automatic handling operations may never involve sliding one sheet or component over another.

Finally, when other handling systems are used, e.g. forklift trucks, it is often sufficient to add a layer of felt or rubber to comply with the handling requirements for organic coated products. Experience has shown that it is preferable for organic coated products to be supported on their least vulnerable side during handling, with the appearance-sensitive front side facing upwards. This also makes it easier to detect any surface defects.

3.3.2 Packaging

Whatever the format (coil, sheets or blanks), organic coated products are shipped in packaging appropriate for the transport and handling conditions, the destination and the intended final use. This point should be discussed with your ArcelorMittal agency.

The packaging of finished parts made from organic coated steel will be the same as for post-painted components. The parts should be placed in boxes, baskets or other containers in such a way that they are separated from one another and protected against damage due to friction or impact. Corrugated cardboard spacers, foam sheets or other similar products can be used for this purpose. Parts must never be stacked in bulk without individual packaging.

3.3.3 Storage

The coils, sheets or blanks must be stored in clean, heated premises, which must be at least sufficiently ventilated to prevent moisture accumulation by capillarity (between sheets or coil laps), which would lead to corrosion. Proper packaging is recommended to allow the coil/bundle to breathe. Moreover, the storage temperature should be as constant as possible to avoid condensation. If storage at a low temperature cannot be avoided, the products must be warmed at about 20 °C for 24 hours prior to processing (see p. 16).

If outdoor storage is unavoidable, the risk of damage occurring will increase, the longer products are stored outdoors.

In fact, even if products are designed with very high durability for their final use (roofing, cladding etc) under various environmental conditions, very specific and severe storage conditions locally may be risky.

Examples of conditions leading to material deterioration during storage:

- The narrow gaps between panels and coil laps are considered to be very confined areas where water can penetrate and collect, leading to specific storage corrosion.
- Damage might also be caused by deterioration of the strippable film. Prolonged exposure to sunlight could make the film more adhesive, and consequently more difficult to remove. In addition, adhesive residues might remain on the organic coated products, increasing the chance of dust, soil etc collecting.

Special precautions must also be taken when handling the products:

- When the sheets are removed from the stack, they should not be dragged, so as to limit the risk of scratching.
- Mechanical damage can occur when coils are placed directly on the ground. We recommend the use of protective mats made of rubber, felt or similar materials, to prevent rough surfaces or debris causing marks or indentations on the first lap of the coils. A small indentation on the outer lap can affect several laps inside the coil.
- Coils and bundles of organic coated sheets must not be allowed to splay or be stacked on top of one another, since this increases the weight on bottom coils. The protective covering should be replaced on all partly used coils and bundles, in order to avoid soiling and damage to the exposed laps or sheets.

We recommend using organic coated products within six months of manufacture in order to conserve maximum flexibility of the organic coatings. After six months, mechanical densification of the structure of the coating may occur, leading to loss of flexibility.

3.4 Recommendations for decoiling, slitting, cutting to length, shearing, punching and mechanical cutting

3.4.1 Decoiling

The drive system for decoiling must be matched to the line speed, in order to optimise product flow. In extreme circumstances, the drive system will also eliminate jerks, and flapping and slipping of adjacent laps.

3.4.2 Slitting, cutting to length, shearing, punching and mechanical cutting

Slitting and other cutting processes for organic coated strip are performed using the same parameters as for other products. It is essential to correctly adjust and sharpen the tools used to avoid the formation of burrs and paint slivers. Because there is no final painting operation to cover the burrs, they will remain visible. Paint slivers and built-up edges can contaminate the tools.

Slitting, cutting-to-length and shearing operations must be considered at the design stage to ensure that any burrs that may result do not affect the appearance of the finished product or pose a safety risk (cuts to the hands) during handling etc. The following rules must be respected in order to control the position of cutting burrs.

Ideally, the sheet should be worked from the coated side (i.e. with the side that will be visible in the finished product uppermost) in order to optimise transformation process control and avoid peeling of the paint in the event of poor tool adjustment.

Symmetrical mounting of the slitting and edging wheels is preferred.

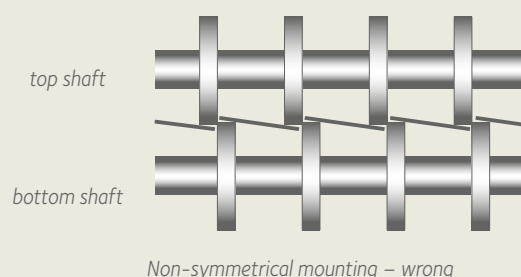
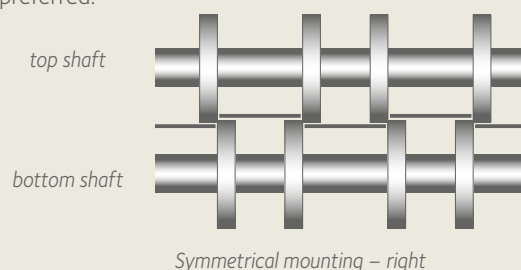

The burrs are then oriented as shown in the diagram below.

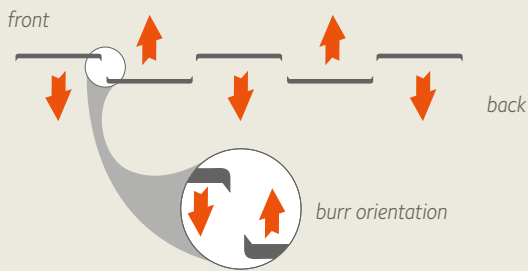

Burr orientation after (symmetrical) slitting

The vertical and horizontal blade clearances for slitting are shown in the following diagram:

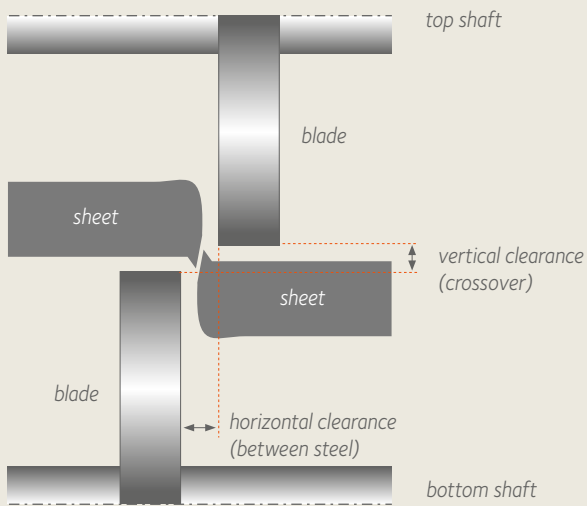

Vertical and horizontal blade clearances in slitting

Slitting quality is considered to be good if:

- The distorted zone is small
- The shear zone occupies about one-third of the thickness
- The fracture zone is sharp, with an angle of less than 5°
- There are few or no burrs
- There are no paint slivers or build-up on the tools

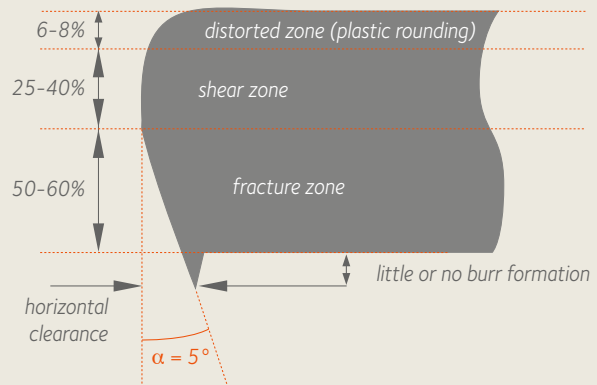

Morphology of the cut edges

Cutting to length with a shear produces burrs oriented in opposite directions on the front and rear edges of the sheet.

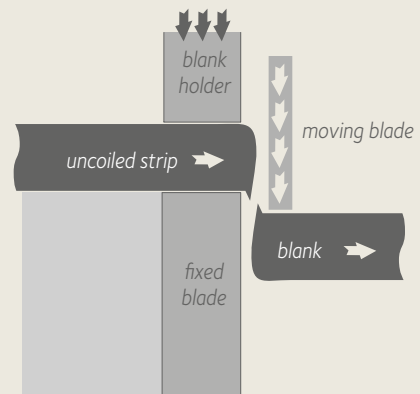

Orientation of burrs after shearing

This aspect is important, since it means that it is essential to stack the sheets perfectly upright.

The use of disk cutters and similar techniques should be ruled out, since they cause coating burns, and generate chips and burrs. For roll forming, for example, profilers will find hydraulic or pneumatic shears at the line exit preferable to circular or band saws.

Furthermore, the choice of a suitable sheet handling system is important, particularly on punching presses. The new mini-brush types are preferable to the old ball systems.

3.4.3 Laser and water jet cutting

In laser cutting, the gas used must be nitrogen. Oxygen burns the organic coating and disrupts the laser beam, leading to a loss of power and the appearance of burrs. The choice of nitrogen increases the cost of cutting due to the high flow-rates required (pressure of 20 bars compared to 1 bar for oxygen).

If the sheet has a temporary protective film, cutting can be performed in two passes, one for the film and one for the organic coated material. If possible, the adhesion of the film should be sufficient to prevent peeling, which could hinder the beam. The best solution is generally to remove the film prior to cutting, in order to preserve the excellent quality of a laser cut (accuracy, narrowness of the heat-affected zone and absence of burrs).

Water jet cutting is highly suitable for organic coated products and requires no special adjustments. Since there is no source of heat and no contact with a tool, this process gives an excellent quality cut, with no burrs, no damage to the organic coatings and no heat-affected zones. The only aspect sometimes requiring attention is the presence of a protective film, which must be prevented from peeling during cutting.

3.4.4 Compatibility with post-painting operations

Coil coated panels can be post-painted by the end user:

- When they are used as the base for an additional coat of decorative paint, which is applied either by sublimation, as a powder or by spraying. The paint is then cured or dried under ambient conditions.
- When localised re-painting is needed in the event of scratching or other damage during installation, for instance; the paint is applied using a brush and dries under ambient conditions.
- When the end product needs to be repainted on site (e.g. roofs); the paint is sprayed and dries under ambient conditions.

For the three cases mentioned, there should be very good compatibility between the paints (coil coated and post-painted) to ensure that the end-product properties are retained (adhesion, corrosion resistance). Consequently:

- The organic coated substrate must be free of dust, oil and other impurities before being re-painted. If delamination has occurred, the paint must be removed (by sand blasting, for instance).
- If bare metal is visible, a primer must be applied, followed by the top coat, in accordance with the paint supplier's recommendations.

As various kinds of post-paints can be used with coil coated products, recommendations depend on the organic coating chemistry, formulation etc. Some details are presented in the following table:

Recommended solution	2-pack PU	1-pack PU
White coils (decorative purposes)		⊕
Building	⊕	
Scratches		⊕
Metallised	⊕ ¹	
Polyester		⊕
Polyurethane	⊕	+
PVC	⊕ ²	

⊕ very good

+ good

¹ use of automotive formulation

² care must be taken with the type of plasticisers in the PVC

For more detailed information, do not hesitate to contact our technical experts and account managers. They will be glad to help you find the best solution for you.



4 Forming of organic coated steel

4.1	Introduction	22
4.2	Drawing	22
4.3	Roll forming	24
4.4	Bending	25
	4.4.1 Flap bending	25
	4.4.2 Narrow punch V-bending	25
4.5	Panel forming	25
4.6	Edge forming/Flanging	26
4.7	Spinning	26

4.1 Introduction

During forming of an organic coated sheet, the appearance-sensitive surface is in direct contact with the tools. The reaction of the material to the forming loads exerted on the surface therefore depends on the behaviour of the organic coating, and this must be allowed for by adapting the process parameters accordingly. For this reason, we recommend using dedicated equipment and workshops, with extremely clean machines and a working temperature at or above the glass transformation point (T_g) (see p. 16).

In order to avoid scratches, or even tearing of the coating in extreme cases, the tool/sheet contact areas should be increased in order to decrease the local contact pressures and limit relative movements and friction between the tools and the organic coated steel.

Increasing the contact area is not always easy to do directly, but can be readily achieved indirectly by polishing the tools.

Relative movements depend on the forming process employed and it is often not simple to minimise them. The friction coefficient can be reduced, however. Polishing the tools is once again an excellent solution, and the use of appropriate lubrication (e.g. a volatile oil) is another possibility. Organic coated sheets will then have a very low friction coefficient, often less than 0.05 with steel tools.

In certain cases, it may be useful to protect the paint layer by adding a temporary organic film. This possible solution must be examined in the light of the intended forming process.

The strain levels arising from the design of the component and the forming process must be compatible with the formability of the steel substrate, the metallic coating when present, and the paint system. This aspect will be discussed in detail in the section on component design (see p. 35).

The thickness to be taken into account when designing a forming process is the total product thickness (steel + metallic coating + paint + protective film). It is this value that determines tool clearances. For thin gauges or applications requiring very precise adjustments, if the thickness of the coatings is not included in the calculation, the coating will be crushed. It is easy to make this mistake, since the organic coated steel thicknesses set out in the standards are the thickness of the steel substrate + metallic coating, but do not include the organic coating.

4.2 Drawing

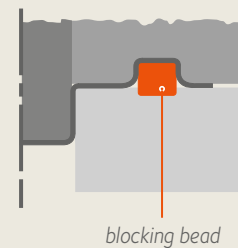
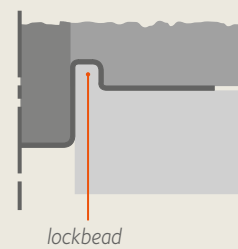
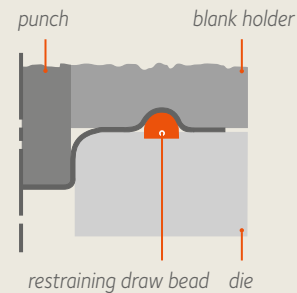

Draw beads and other restraining devices must be avoided

In the drawing process, the surfaces of the organic coating are subjected to different loading configurations, the major stresses being due to deformation and contact pressures. The strain levels must remain compatible with the deformation capacities of the substrate and the coatings. These maximum levels are given by the forming limit curve (FLC) of the material. This curve is valid for direct strain paths and constant strain state throughout the thickness. For deformation greater than the FLC, the material will undergo necking or failure.

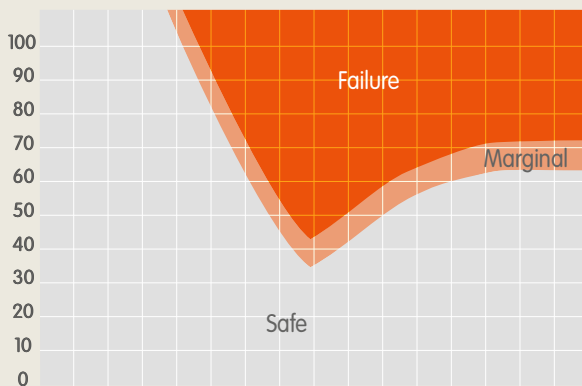

The different deformation modes (contraction, expansion, plane strain tension, deep drawing, uniaxial traction and shearing) each have specific effects. Contraction, or necking, must be closely controlled, since it causes an increase in thickness, which can cancel out the permitted tooling clearances.

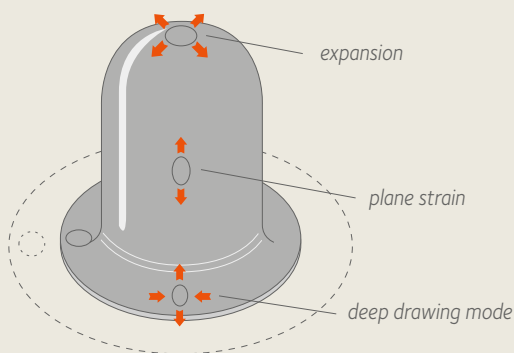

Different deformation modes in a drawn component

The pressures generated in drawing are relatively high and often reach 5 to 10 MPa. Friction must be closely monitored, since it can seriously damage the organic coating. The use of draw beads and other restraining devices should therefore be avoided. Hard spots on the tools, e.g. due to poor machining or hardfacing in certain zones, must be eliminated.

Similarly, die entry radii should be increased as far as possible. The clearances between the punch and die should always be equal to the total thickness of the organic coated sheet plus 5 to 10%, depending on the case.

Polishing and the use of sufficiently hard tools (e.g. high alloy steels such as Z160CDV12, Z200CDV12 and Z230CDV12-4) are the most appropriate solutions. Lubrication using a soluble or volatile oil (to avoid the need for degreasing) is another possible option. However, this requires increasing the blank holder pressure to reduce the greater risk of slippage and the associated risk of wrinkling. It is advisable to locally increase the size of the blank in 'draping' zones in order to minimise wrinkling.

With high production rates, it may be necessary to cool the tool in extreme cases.

It should also be noted that high stretching or drawing strains may modify the surface finish and gloss of the coating. These changes in appearance may be accompanied by a loss of corrosion resistance in aggressive environments (humid and salty atmospheres etc). Laboratory tests should be performed in such special cases.

Special tools have therefore been developed at ArcelorMittal to:

- Evaluate both colour and gloss changes during the forming process
- Measure and simulate the forming process

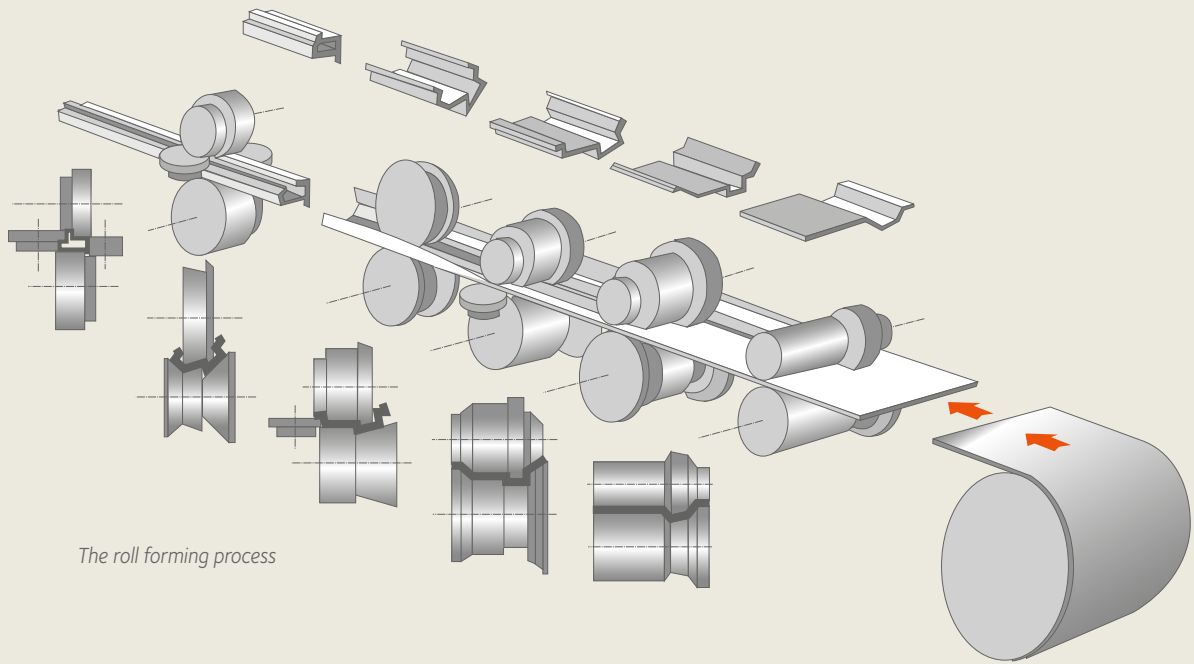

The roll forming process

4.3 Roll forming

The same factors are important in roll forming of organic coated steel, i.e. the flexibility and adhesion of the coating in bends and its resistance to contact pressure and friction.

The first of these aspects will be considered in detail later, in the section dealing with design (see p. 35).

For resistance to contact pressure, the solutions are different from those applicable for drawing processes. Firstly, the diameter of the rolls must be as large as possible. Secondly, all sharp angles on the rolls must be eliminated and replaced by fillets.

In order to prevent slippage, the ideal solution is to have tools with counter-rolls mounted on bearings. This is a technically simple solution that presents no additional difficulties in terms of maintenance, and the initial investment is only marginally higher.

As in the case of drawing tools, particular attention must be paid to the roughness and hardness of the rolls. The best roll materials are low or high alloy steels (35NCD4, 100C6, Z200C13 etc), quenched, ground and – if possible – polished. The application of a layer of chrome is the ideal solution.

Whereas lubrication is essential in roll forming of galvanised steel to prevent the coating sticking to the tools, it is often not necessary for organic coated steel, in view of the excellent properties of modern organic coatings. Furthermore, with complex profile geometries, it may be difficult to eliminate the lubricant.

A temporary protective film is another solution to facilitate roll forming and safeguard the organic coating. This solution is frequently employed for wide sections such as those used in the building industry, but can prove more difficult for complex profiles. This point will be discussed further at a later stage. Evanescent lubricants may also be used (cf. 6.2).

For small roll-formed profiles, most tooling processes are designed with very small or zero clearances, in order to ensure accurate dimensions. However, this approach is not suitable for organic coated steel, since a degree of clearance is necessary to avoid damaging the paint coating. For wide profiles, a clearance of one or two tenths of a millimetre is generally necessary for a sheet thickness of 0.7 mm. As in drawing, it is the total sheet thickness that counts, including the organic coating and protective film.

4.4 Bending

In bending processes, deformation strains can be controlled in the same way as for roll forming. However, the management of contact pressures depends on the bending process used. There are two possible methods.

4.4.1 Flap bending

Flap bending is an excellent method in terms of the contact pressures involved, since the pressure is spread over the surface area of the flap. Moreover, relative movement between the steel sheet and the tools is minimised.

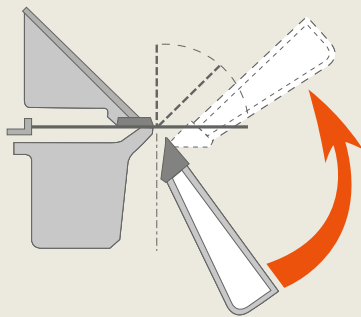

Principle of flap bending

4.4.2 Narrow punch V-bending

In narrow punch V-bending the pressures generated are higher, since the contact occurs along a line rather than over a surface area. Furthermore, the coated sheet slides over the die entry radii.

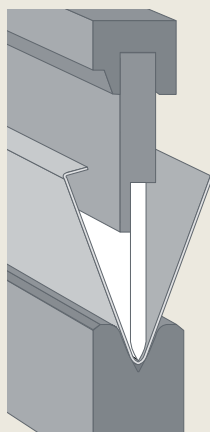

Narrow punch V-bending

Effect of the die: The basic rule in V-bending is to use a die opening 6 to 12 times the sheet thickness. For bending organic coated sheet, the higher value is preferable, i.e. 12 times the thickness. This is a simple choice involving no extra cost and has several advantages. Since bending leverage is

increased, contact pressures are decreased in inverse proportion. The bending or natural radius of the sheet increases, thereby reducing the strain in the coatings. The increased die entry radius also lowers contact pressures and friction.

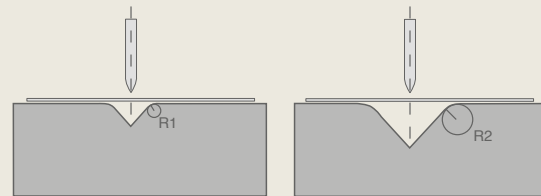

V-bending with narrow and wide dies

Effect of the punch: There are several different types of tools available. The most commonly used type has a nose radius smaller than the natural radius of the sheet – generally between 0.6 and 0.8 mm. Other types have larger radii, of the order of a few millimetres, generating larger bending radii in the sheet and therefore greatly reduced deformation strains in the organic coatings (see p. 36).

4.5 Panel forming

Panel forming is very similar in principle to flap bending and the same solutions can be employed.

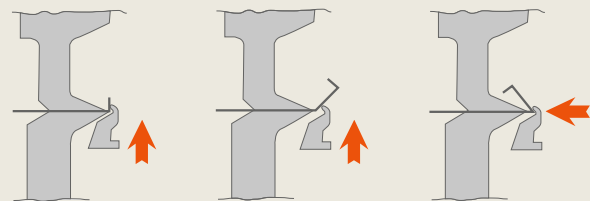

Bending on a panel forming machine

This method is very easy to automate and therefore frequently used in integrated manufacturing lines. It is not necessary to turn the sheet over to produce reverse bends and it is possible to work on all four sides of a panel by means of a simple 90° rotation. Production times and handling of organic coated components are thus minimised.

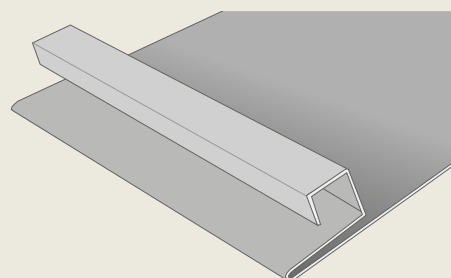

Component with positive and negative bends

4.6 Edge forming/Flanging

The control of strain during flanging is similar to that in roll-forming and bending processes.

Tool/workpiece contact is different on the inside and outside surfaces of the bend. On the inside, contact occurs over a surface area and pressure is fairly light. In contrast, on the outside, contact with the punch (blade) is often linear and pressure is more acute. This is therefore where the potential difficulties lie. To minimise this problem, the tools must be polished, and this is especially important for the punch. Clearance must be sufficient to avoid crushing the paint layer. The punch edge radius should be as large as possible.

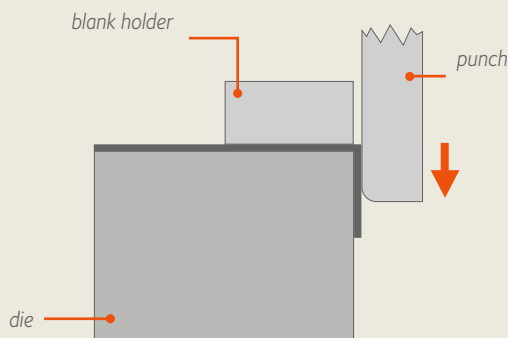

Edge forming by conventional flanging

In the conventional flanging process, elastic spring back is controlled by ironing, i.e. reducing the thickness of the sheet. For organic coated steel, the process must be modified to avoid severe damage to the coating.

The best solution is to use an articulated punch and cam system, in which the punch can rotate in addition to vertical displacement. This system also limits sliding during tool withdrawal. The process configuration is somewhat similar to that of flap bending.

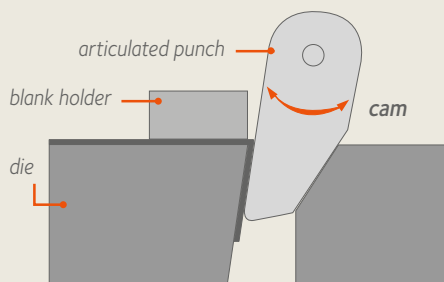

Edge forming/flanging with an articulated tool

4.7 Spinning

Spinning is a process that can induce high forming strains, and from this point of view it is similar to drawing.

In order to avoid damage to the paint coating, the roll must have a large diameter and a perfectly polished surface. The surface of the mandrel must be equally well polished to ensure that the steel sheet slides easily.

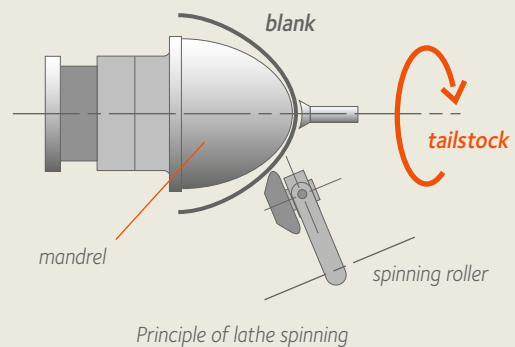

Principle of lathe spinning

In difficult cases, involving extreme deformation or high strength steel substrates, the rotation and feed rates must be reduced to prevent overheating. The organic coated steel can also be cooled with compressed air or lubricated with soluble or volatile oil. However, the latter solution is only possible on a numerically controlled machine tool, due to the projections.

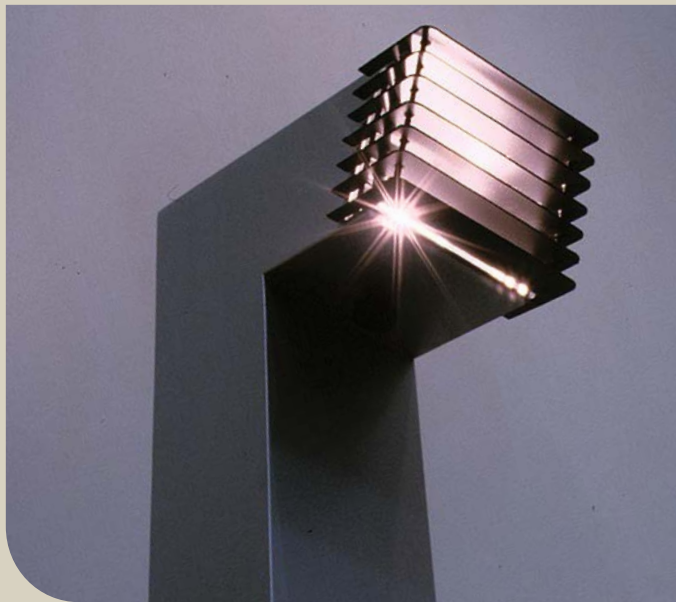

5 Joining of organic coated steel

5.1	Adhesive bonding	28
5.2	Clinching	29
5.3	Riveting	29
5.4	Lock seaming	30
5.5	Joining with bolts, studs, clips etc	30
5.6	Welding	31
5.6.1	Resistance welding	31
5.6.2	Arc welding techniques	32
5.6.3	Resistance butt welding (ERW)	32
5.6.4	Laser welding	32
5.6.5	Welding of pins	32

When designing a new component, the mechanical and aesthetic aspects of how it is to be assembled must be taken into account right from the beginning. This point will be discussed in more detail later. However, what may appear to be a difficulty may in fact be an opportunity to switch to cleaner and less noisy joining processes.

5.1 Adhesive bonding

Adhesive bonding is ideal for organic coated steel, which is an intrinsically clean product and an excellent substrate for adhesives. In order to obtain good adhesion and cohesion in the bond, the compatibility of the adhesive and the organic coating should be ascertained prior to use. This aspect must be examined in detail, since each organic coating/adhesive combination has its own specific characteristics. Moreover, the durability of the bond may vary with the environment to which the finished component is exposed. Please contact ArcelorMittal's specialists on this point.

An adhesive bonded structure is a complex composite system, the efficiency of which depends not only on the choice of adhesive but also on the cohesion of all the constituent layers. Failure of a joint may occur in the adhesive, in the metal or organic coating, or at one of the interfaces (metal/metallic coating/primer/top coat/adhesive). Tests must be performed to determine the optimum technical and economic solution for each case. An important point is the fact that adhesive bonded joints in organic coated sheets exhibit a much better wet ageing performance than uncoated metal or galvanised surfaces. Two-component polyurethane adhesives are an excellent choice for many applications.

Adhesive bonding has numerous advantages. Loads are spread perfectly as a result of the continuous bond created. With certain specific products, it can also perform sealing and vibration-damping functions. The joints have an attractive appearance, and the substrates undergo no thermal or mechanical damage.

The adhesive can be polymerised efficiently and rapidly using various techniques, either chemically (by means of a catalyst or activating agent) or thermally (using an oven, heating press, induction, infrared heaters etc). In order to facilitate handling of components before polymerisation is complete, clinching or other similar joining processes can also be carried out at various sites on the component.

Adhesive bonded joints are generally lap joints.

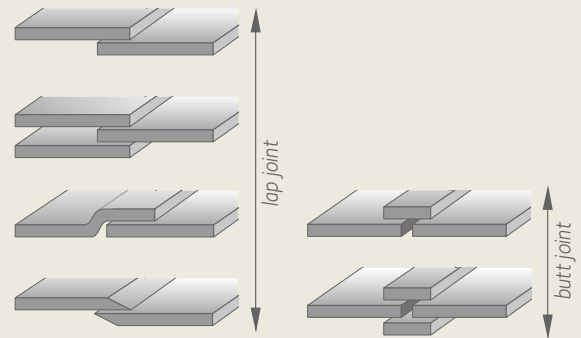

Recommended adhesive bonded joint configurations

Shear, tensile and compressive stresses are preferable to peeling and cleavage, which should be avoided.

Before bonding, check that the surfaces to be joined are dry and not contaminated with chemical substances (oil, grease etc) or dust particles. In the event of contamination, they must be wiped with a clean rag or cleaned with a soft brush, then with a cloth soaked in isopropyl alcohol. In extreme circumstances, the contact surfaces can be protected with an organic film, which should be removed just before bonding.

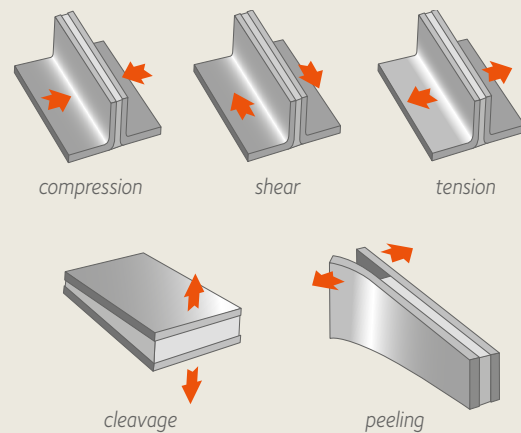

Different types of joint loading

It should be noted that the range of products that can be produced on a painting line includes steels precoated with an adhesive, which can be reactivated thermally.

5.2 Clinching

Clinching is an excellent method of joining organic coated sheets.

It enables materials of a very different nature to be joined without using additional products. With suitable precautions (see below), it preserves the corrosion resistance of the coatings. Clinching is a clean process, producing no fumes or slag. It is relatively quiet, and consumes little energy. It can be readily automated and easily integrated into various types of manufacturing lines (e.g. roll forming). Finally, clinched joints have good fatigue strength.

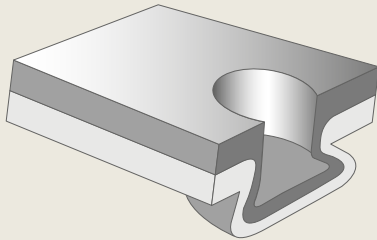

The clinching capacity of a sheet is directly linked to the grade of steel employed. In order to guarantee the attractive appearance of the clinched points, local lubrication with volatile oil may prove necessary. This will limit friction between the punch, the surface of the organic coated steel, and the die. Here again, heating is an excellent means of ensuring the flexibility of the organic coating and its formability during clinching. A protective film may also be beneficial in this respect, but it must never be placed between the two sheets to be clinched.

With regard to the appearance of the component, each clinching point produces a hump and a hollow. Since the static strength of a clinch is less than that of a spot weld, a greater density of points is required. The clinching tool must be perfectly perpendicular to the sheets and the punch must be precisely positioned with respect to the die. The sheet thicknesses must be less than 3 mm, with a ratio between the two thicknesses not greater than 2.

5.3 Riveting

Riveting of coil coated products requires no special precautions in addition to those required for cold rolled, galvanised or electrogalvanised steel. Care must be taken to choose the right rivet material, since otherwise galvanic coupling can occur between the rivet and the substrate. As a consequence, blistering of the organic layer can appear in this area.

There are three possible riveting techniques:

Conventional riveting

whereby holes are drilled before the rivet is introduced and deformed.

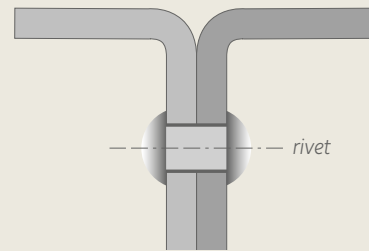

Blind riveting

for which only one side of the joint needs to be accessible, since the hollow rivet is deformed by a central shaft. Different models exist, including explosive head and threaded shaft types, or systems in which the head or shaft snaps.

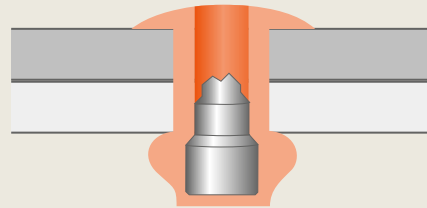

Self-piercing rivets

require only one operation, since as the name suggests, the rivet itself pierces the sheet.

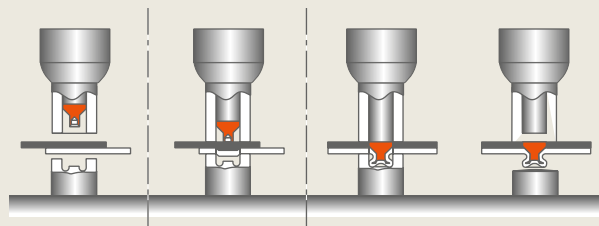

The advantages of self-piercing rivets are similar to those for clinching, and the process also gives higher resistance to static loading. However, this technique is less suitable for thin sheets.

Riveting can be used to join different types of products without affecting the corrosion resistance of the coatings in any way if the compatibility between the rivet and the substrate has been checked. Riveting methods are relatively quiet and have low energy consumption. However, the joints cannot be disassembled and are aesthetically unattractive. Nevertheless, the processes can be easily automated, making them

competitive when compared with other mechanical joining systems, although they are more expensive than adhesive bonding, clinching etc due to the cost of the rivets.

Certain provisos need to be mentioned:

- For self-piercing rivets, the maximum thickness of the assembly is 6 mm
- This limit decreases if the steel mechanical properties increase
- For other types of riveting, there is no known limit
- The technique is not very suitable for thin sheets

5.4 Lock seaming

Lock seaming is a technique involving plastic deformation of the steel to make the join. It is perfectly suitable for organic coated steel, providing that the metallic and organic coatings are chosen to withstand the strains generated in the folds.

Lock seaming satisfactorily preserves the corrosion resistance of the coatings and can be easily combined with adhesive bonding. The joint can be made perfectly leaktight by using a sealing compound, an adhesive or a rubber seal. Wherever possible, the seam should be designed so that the sheet edges are not visible, both for aesthetic reasons and for optimum corrosion resistance.

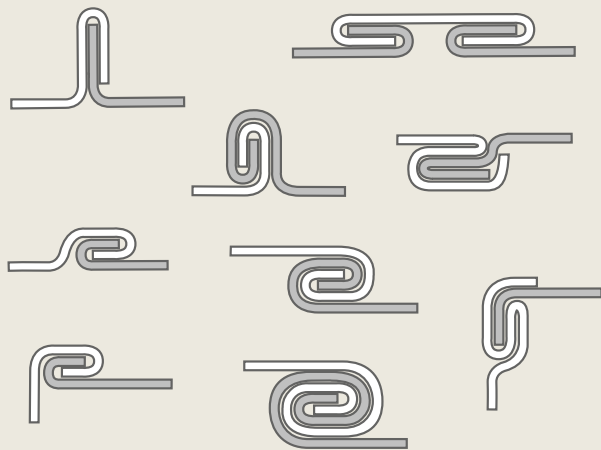

Different single and double lock seams

However, lock seaming is only suitable for parts with a simple geometric design, and cannot be used for corners. The joints cannot be dismantled, and have low resistance to sliding in a direction parallel to the folds, and low resistance to opening perpendicular to the folds. With lock seaming, folding strains are often severe, requiring the use of extremely flexible organic coatings.

Lock seaming is economical for large production runs, even though the design of the tooling can be a lengthy and difficult process.

5.5 Joining with bolts, studs, clips etc

These mechanical joining methods are also perfectly suited for use with organic coated steel, and can be used to join products of completely different types without reducing their corrosion resistance. The joints can be readily dismantled, but are aesthetically unattractive, even when covered by coloured plastic caps. These methods represent a significant additional cost in terms of materials and labour. Mechanical joining of this type is relatively silent and consumes little energy, but is difficult to automate.

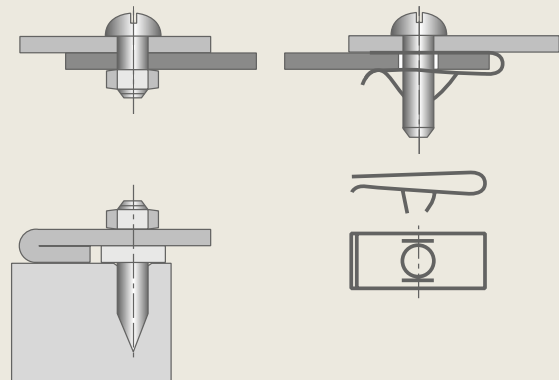

Various mechanical joining techniques (bolts, studs, clips etc)

As for riveting, care must be taken to choose the right material, since galvanic coupling can occur between the bolt and the substrate.

5.6 Welding

In general, conventional welding techniques have a negative effect on the appearance of organic coated sheet and lead to a loss of corrosion resistance. Protection of the weld zones is therefore necessary if the part is exposed to an aggressive environment.

However, certain techniques such as electrical discharge welding of studs give good results without damaging the coating.

During the welding process, fumes are released. Their composition very much depends on the product/paint involved:

- volatile organic compounds (VOC)
- semi-volatile organic compounds, e.g. unburnt products such as tars
- inorganic particles (Fe, Zn, Al etc) originating from the substrate, the metallic coating or paint pigments

However, as mentioned above, fume composition and concentration depend not only on the organic coated product in question but also on the welding process (frequency, condition etc). In order to minimise any risk, the customer must provide a well-ventilated working area and suitable equipment for the welders.

ArcelorMittal is willing to help customers to reduce the potential risk at their facilities and to find an appropriate fume recycling process. Product safety data sheets can be found on ArcelorMittal's website.

5.6.1 Resistance welding

Because of its non-conductivity, organic coated strip is not suitable for resistance welding, except in the case of specific organic coatings that are described as weldable. Their overall static strength is nevertheless of the order of 500 mW, compared with 0.02 to 0.05 mW for electrogalvanised steel. Electrodes with hemispherical contact surfaces facilitate passage of the current by localising the force. The weldability range is generally shifted to lower currents, representing an advantage for industrial processes.

Welding can be facilitated by mechanically removing the coating at the points to be joined. In a few rare cases, the electrodes can be brought into contact with the bare or zinc coated sides of sheets painted on one side, the painted sides being in contact.

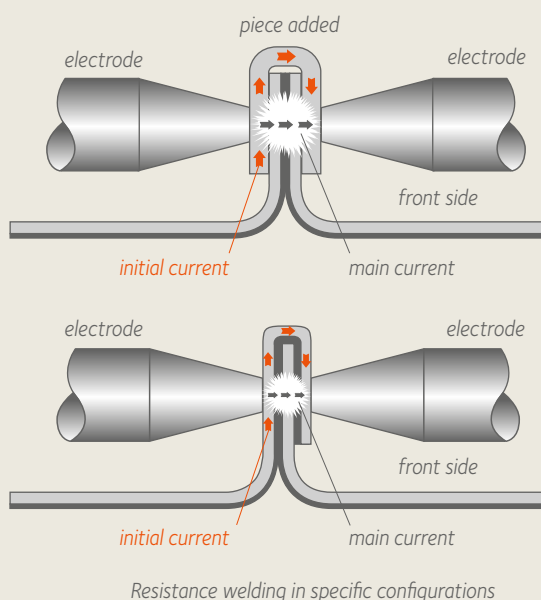

This welding process involves no special difficulties with regard to the welding parameters compared with bare or zinc coated steel. The electrode lifespan, with readjustment of the current, remains of the same order or better than that for zinc coated sheets. Values of 1000 to 1800 spots have been obtained with certain weldable organic coated products. A repetitive sound and fume emission can sometimes occur, without disturbing the welding process or in any way modifying the quality of the joint. Finally, the mechanical strength of the weld spots is identical to that obtained with uncoated or zinc coated steel.

5.6.2 Arc welding techniques

In these different processes (MIG, MAG, TIG, plasma etc), the steel is brought to melting temperature. As a result, the coatings are vaporised and contaminate the melt pool. This can create open porosity in the weld seam or may generate projections (MAG welding) or interruptions of the arc (TIG welding).

The coatings are burnt in a wide heat-affected zone around the weld. Mechanical removal of the coating in the weld zone is preferable to eliminate these problems, and for this reason, butt welds are easier to perform than lap welds. Certain positions of the parts during welding promote the evacuation of fumes.

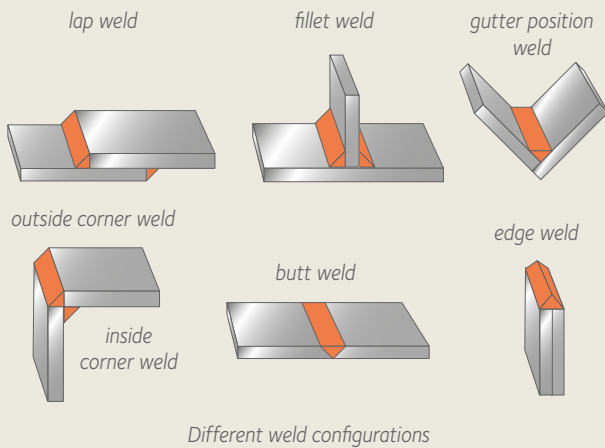

Different weld configurations

As a result, these processes are generally not suitable for organic coated products.

5.6.3 Resistance butt welding (ERW)

This technique is widely employed in the manufacture of roll-formed tubes. It can be directly applied to organic coated sheets heated by induction, but since it creates a wide heat-affected zone in which the paint is degraded, its use is limited.

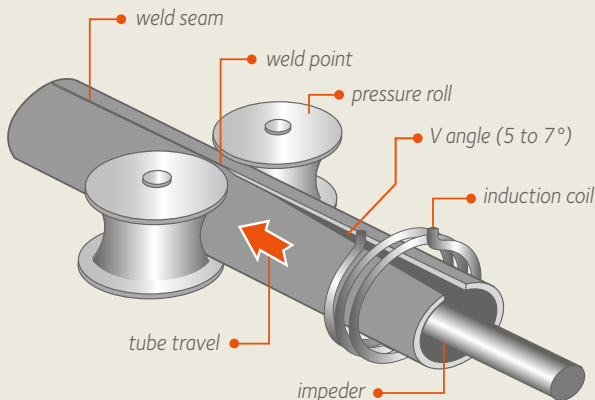

Resistance butt welding

5.6.4 Laser welding

This process requires precise assembly of the sheet edges in order to prevent disturbance of the laser beam by fume emissions produced by excessive contact with the sheet surfaces. As in the case of arc welding, it is possible to remove the organic coating along the weld line.

The principal advantage of laser welding is the narrow heat-affected zone, which is only a few millimetres wide.

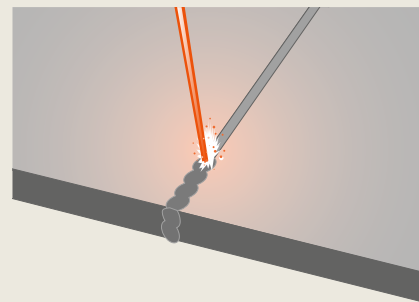

Laser edge welding

5.6.5 Welding of pins

Various processes can be used to weld pins to organic coated steel, but the only method applicable to all types of organic coated steel, whether electrically conducting or not, is electrical discharge welding. When the different welding parameters are correctly adjusted, it is easy to preserve a perfect appearance of the coating on the side opposite to the weld spot, with excellent corrosion resistance of the whole zone. This makes the process extremely attractive. The presence of slight splashes around the edge of the weld has no effect on the coating.

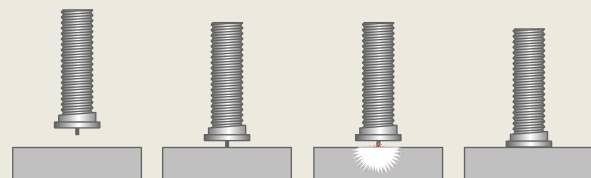

Welding a pin by electrical discharge welding

The pulsed arc process requires electrically conducting coatings and marks the rear side of the coated sheet. The stud inert gas (SIG) process is applicable to all types of coating, but causes significant coating damage.



6 Protection and manufacturing aids

- 6.1 Temporary protective films 34
- 6.2 Lubricants and cleaning solvents 34

6.1 Temporary protective films

A temporary protective film applied as the steel leaves the organic coating line, or at a later stage, is an excellent way to reduce the risks of scratching during processing, or, in the case of painted sheets, during transportation. However, it entails additional costs for both application and removal, which must be carried out at the latest possible stage. This peeling operation is generally performed on the finished component, often by the final customer, if the film is left in place to protect the component until arrival. However, for complex shapes, film removal can be a laborious process.

Films usually cause no problems for bending, roll forming, slitting, cutting etc. The usefulness of a protective film thus depends essentially on the protection required during the processing operations to be performed. Controversially, in certain cases, the film may hinder processing, for example in drawing (except for specially designed films), laser cutting and adhesive bonding.

The thickness of the protective film (usually between 35 and 120 microns) must be taken into account when determining clearances. A thin film permits visual inspection of the product during processing. A thick film will provide better protection for the steel but since it is opaque, it will prevent proper inspection.

The use of protective films calls for certain precautions during outdoor storage. If condensation is trapped between the film and the organic coating, there is a risk of corrosion. We recommend that the film should be removed within three months and at ambient temperature. Film-coated products must not be stored in sunlight, or at extreme temperatures.

Finally, the film should be peeled off rapidly after severe forming operations such as deep drawing, since high pressures lead to a loss of peelability with time.

6.2 Lubricants and cleaning solvents

In cases where lubrication is necessary, it is important to choose the right lubricant. Volatile oils are preferred, since they generally eliminate the need for degreasing. In some cases, they may be directly compatible with a final adhesive bonding or painting operation. They are applied using low-pressure microspray or aerosol systems, or by roll coating etc. Another solution is to use soluble oils. However, these require more complex installations for their recovery and treatment. Greases, waxes and similar products should be avoided, since they are difficult to eliminate without using solvents, which are often incompatible with organic coatings.

Solvents such as isopropyl alcohol are the best choice for cleaning organic coated sheets, if this proves to be necessary. Methyl ethyl ketone (MEK) and ethyl acetate solvents must be avoided since they can attack the organic coating. The simplest solution for cleaning these products is to use soapy water.



7 Design

7.1	Shape design	36
7.2	Joint design	37
7.3	Design of edges and corners	37
7.4	Design support	38

In order to successfully design a component using organic coated steel, three aspects must be considered, namely shapes, joints, and edges and corners. Other factors, such as stiffness, fatigue strength etc, will not be discussed here, since they are not specific to organic coated steel.

7.1 Shape design

Component geometry has a direct influence on the strain that the metal is subjected to during forming. The choice of geometry therefore determines the feasibility of fabrication. This aspect is now well understood by all designers in the case of uncoated, galvanised and electrogalvanised steel.

For organic coated steel, the same principles apply, but designers must also check that the organic coatings are able to withstand the deformations involved.

Organic coatings have their own specific characteristics (adhesion, flexibility, hardness, corrosion resistance etc). Some can withstand very high strains such as occur in 180° folds, for example, while others are less tolerant. It is not always possible to combine the best performance characteristics for all properties. However, it is always possible to find an optimum compromise that meets the specifications as closely as possible.

It is therefore important not to introduce unnecessarily high strains at the design stage, in order to retain the widest choice of coatings with an optimum balance between the different performance characteristics.

Roll forming, bending, panel forming and similar processes induce bending strains in the coatings at folds, which can be correctly predicted from the following equation:

$$\epsilon = \frac{t}{t + 2 \cdot Ri} \quad (1)$$

where t is the sheet thickness and Ri is the internal bending radius.

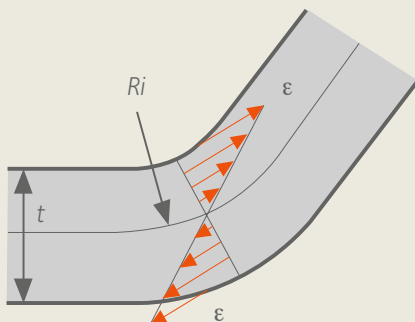

However, this equation underestimates the strain when the bending radius approaches the sheet thickness (e.g. in 180° folds).

The curve below shows the strain values calculated with the equation as a function of the Ri/t ratio and demonstrates the logarithmic influence of the bending radius.

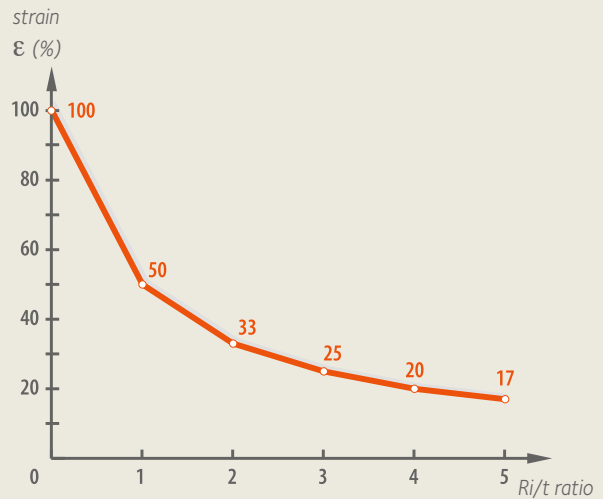







Bending strain as a function of the Ri/t ratio

Even a simple bending radius must therefore be chosen with great care. The organic coating must be taken into account: it must have all the required properties and at the same time withstand the forming strains.

Pragmatic bending tests as per EN 13523 can be useful for assessing the ability of organic coated steel to withstand the final component shape.

In the case of the drawing process, the strains that the organic coating has to withstand are more complex. These can be correctly estimated by simulation using finite element software, based on a preliminary geometrical definition of the component. They can also be determined experimentally by measurements on the component.

The ECCA* and NCCA* tests are used to define coating formability (flexibility and adhesion), based on a 180° bending test. Since coil coated sheets are often tested against these standards, it is useful to know how the two different approaches correspond to one another.

ECCA index*	NCCA index*	Bending test	ϵ (%) ⁽¹⁾
0 T	0 T		>100
0.5 T	1 T		≈50
1 T	2 T		≈33
1.5 T	3 T		≈25
2 T	4 T		≈20
2.5 T	5 T		≈17

* ECCA: European Coil Coating Association
NCCA: National Coil Coating Association (USA)

Finally, if the different bending processes are examined closely, it can be seen that they are not all equivalent from this point of view. Flap bending and panel forming processes generate very little interfering (membrane) strains in the sheet. The neutral fibre remains at mid-thickness, and the coating is subjected only to the bending strain. In contrast, press bending displaces the neutral fibre towards the inside of the bend, so that the coating is subjected to an additional tensile strain. In narrow punch V-bending, the neutral fibre is taken to be 0.4 times the sheet thickness, while in forge bending it is 0.25 times the thickness (from the inside edge). This significantly increases the strain in the coating, the only advantage being the limitation of elastic spring back.

Whatever the situation, forming strains must be minimised to keep the widest possible choice of coatings open, so that optimum compliance with the different property requirements can be achieved. The geometry must therefore have fillet radii that are as large as possible and the forming process must be adjusted (blank holder pressure, lubrication) so as to avoid excessive tensile stresses in the sheet.

These choices also have a positive influence on the contact pressures exerted by the tooling on the organic coatings, thereby reducing the risk of scratching or tearing.

7.2 Joint design

Joints must preserve the properties of the coatings and the visible areas must remain aesthetically attractive.

Since most types of organic coated steel have electrical insulating properties, this material is difficult to weld by resistance processes. Arc welding processes involving complete melting are also problematic, because of contamination of the melt pool by the coatings. These factors limit the choice of joining processes in comparison with post-painted sheets, and the use of other assembly techniques is usually the best solution. First of all, the required properties and performance levels must be defined, and this will guide the choice of joining technique. In practice, it is rarely necessary to attain a performance level equal to that of spot welding to obtain a durable joint that is perfectly adequate for the requirements.

Details of the different joining techniques available for organic coated sheet are given in chapter 5 (see p. 27).

7.3 Design of edges and corners

Many designers worry about corrosion resistance at edges and corners, and on the sheet surface in the event of scratches. In fact, the corrosion resistance of organic coated steel is perfectly guaranteed by the presence of a sacrificial zinc-based metal coating and a paint primer containing corrosion inhibitors. The application of primer coats on both sides enhances the corrosion resistance of the sheet edges.

Organic coated steel has all the necessary elements to ensure satisfactory corrosion resistance, at least as good as for post-painted sheet, and distinctly better than a steel sheet with only a zinc coating.

In a few rare, highly aggressive situations, it can be an advantage to fold the edges, in order to prevent them from coming into direct contact with a humid environment. Rounded or drop-shaped folds are to be preferred to fully flattened ones to minimise strains. Another possibility for protecting highly exposed zones is the use of a sealing compound or similar product.

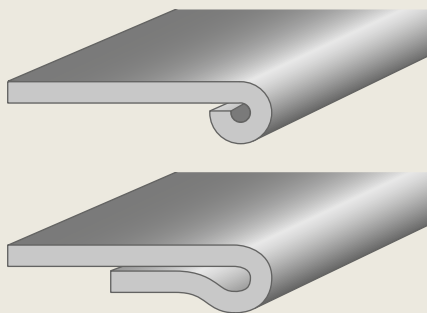

Solutions for edge protection

The aesthetic appearance of sheet edges is not as good as in post-painted products. Different solutions can be envisaged, such as 180° folds (hems) or the use of synthetic edge covers. However, it is generally preferable to modify the component design so as to locate the edges where they will not be visible, for example at the back of the component, or to ensure that they are covered by other parts.

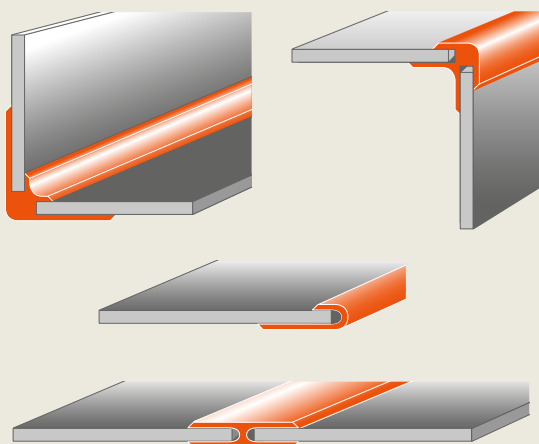

Solutions using synthetic edge covers

This problem also concerns corners, since good corner appearance is often one of the specifications. As before, it is often possible to fold the corners so that the edges are not visible. In drawn components, the corners must be designed with large radii to avoid the risk of damage to the coating during the forming operation. This aspect has already been discussed in the section on forming (see p. 21).

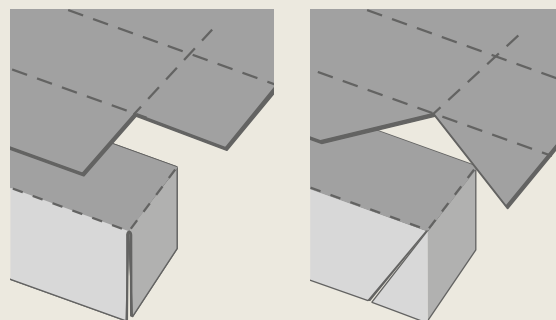

Examples of designs with no visible edges

Other solutions now exist for the forming of corners (Wemo, Eckold techniques etc).

Organic coated steel offers numerous advantages due to the many possible combinations. For example, steel sheets can have a different finish, colour or appearance on each side, or be painted on one side only etc. Any request must be examined in detail, since the paints applied on the two sides must be compatible in terms of curing temperature, for example, or to avoid the risk of marbling (pressure marks that can appear during storage).

In conclusion, component design imposes or implies important choices with regard to the organic coatings. It is essential to determine the best compromise between properties and coating cost while meeting the specifications and complying with processing requirements. This is only possible if precise specifications have been defined based on the required functions and performance characteristics of the final product.

Co-operation between component designers and ArcelorMittal's technical experts and account managers is therefore a powerful advantage in ensuring the successful use of organic coated steel.

7.4 Design support

ArcelorMittal can support you in the design of the elements of your system, either with a feasibility analysis in order to prevent any defect from the outset and to select the most appropriate steel grade and thickness based on optimisation of formability safety margins, or to assess the deformations inside the actual part.

Credits

Cover: photograph by Jeroen Op de Beeck

p. 5: Jeroen Op de Beeck

p. 9: Jeroen Op de Beeck

p. 15: Philippe Vandenameele

p. 21: SCH Holland b.v.

p. 27: Jeroen Op de Beeck

p. 33: Philippe Vandenameele

p. 35: Jeroen Op de Beeck

Copyright

All rights reserved. No part of the present publication may be reproduced in any form or by any means whatsoever, without prior permission from ArcelorMittal Europe – Flat Products.

Care has been taken that the information in this publication is accurate, but ArcelorMittal Europe – Flat Products and any other ArcelorMittal Group company do not accept responsibility or liability for any errors or information which is found to be misleading.

As this document may be subject to change, please consult the latest information in the product document centre at industry.arcelormittal.com

ArcelorMittal Europe – Flat Products

24-26, boulevard d'Avranches
L-1160 Luxembourg

flateurope.technical.assistance@arcelormittal.com
industry.arcelormittal.com